

# I-95™ Operating Instructions

For 1-1/4" through 4"  
(30mm—100mm)



Your I-95 is designed to give you years of trouble-free, profitable service. However, no machine is better than its operator.

Read, understand and follow all safety warnings and instructions provided with the product. Failure to follow the warnings and instructions may result in electric shock and/or serious injury. Save all warnings and instructions for future reference.

**SAVE THESE INSTRUCTIONS!**

**General**  
**PIPE CLEANERS**



## WARNING

Read and understand operator's manual before using this machine. Failure to follow operating instructions could result in death or serious injury.

**WARNING!** Read and understand all instructions. Failure to follow all instructions listed below may result in electric shock, fire and/or serious personal injury. Replacement manuals are available upon request at no charge, or may be downloaded from our website, [www.drainbrain.com](http://www.drainbrain.com). Instructional videos are available for download on our website, and may be ordered. If you have any questions or problems, please call General's customer service department at 412-771-6300.

### SAVE THESE INSTRUCTIONS!

These instructions are intended to familiarize all personnel with the safe operation and maintenance procedures for the I-95.

## SAFETY SYMBOLS



This is the safety alert symbol. It is used to alert you to potential personal injury hazards. Obey all safety messages that follow this symbol to avoid possible injury or death.

## DANGER

DANGER indicates a hazard with a high level of risk which, if not avoided, will result in death or serious injury.

## WARNING

WARNING indicates a hazard with a medium level of risk which, if not avoided, could result in death or serious injury.

## CAUTION

CAUTION indicates a hazard with a low level of risk which, if not avoided, will result in minor or moderate injury.

## WARNING



Electric shock resulting in death can occur if you plug this machine into an improperly wired outlet. If the ground wire is electrified, you can be electrocuted by just touching the machine, even when the power switch is off. A ground fault circuit interrupter will not protect you in this situation. Use a UL approved tester to determine if the outlet is safe.



Do not operate power tools in explosive atmospheres, such as in the presence of flammable liquids, gases, or dust. Power tools create sparks which may ignite the dust of fumes.



Only wear leather gloves. Never use any other type of glove, such as cloth, rubber, or coated gloves. Never grasp a rotating cable with a rag. These items could become wrapped around the cable and cause serious injury.



Always wear safety glasses and rubber soled, non-slip shoes. Use of this safety equipment may prevent serious injury.



Never operate machine with belt guard removed. Fingers can get caught between belt and pulley.

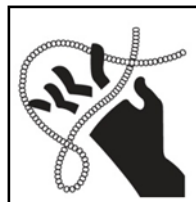

Do not overstress cables. Overstressing cables may cause twisting, kinking, or breaking of the cable and may result in serious injury.

## GENERAL SAFETY RULES



### WARNING

Read and understand all instructions. Failure to follow all instructions listed below may result in electric shock, fire, and/or serious injury.

#### SAVE THESE INSTRUCTIONS!

### Work Area

1. **Keep work area clean and well lit.** Cluttered benches and dark areas invite accidents.
2. **Do not operate power tools in explosive atmospheres, such as in the presence of flammable liquids, gases, or dust.** Power tools create sparks which may ignite the dust or fumes.
3. **Keep bystanders, children, and visitors away while operating a power tool.** Distractions can cause you to lose control.

### Electrical Safety

1. **Grounded tools must be plugged into an outlet, properly installed and grounded in accordance with all codes and ordinances. Never remove the grounding prong or modify the plug in any way. Do not use any adapter plugs. Check with a qualified electrician if you are in doubt as to whether the outlet is properly grounded.** If the tool should electrically malfunction or break down, grounding provides a low resistance path to carry electricity away from the user.
2. **Avoid body contact with grounded surfaces such as pipes, radiators, ranges and refrigerators.** There is an increased risk of electric shock if your body is grounded.
3. **Do not expose power tools to rain or wet conditions.** Water entering a power tool will increase the risk of electric shock.
4. **Do not abuse the cord. Never use the cord to carry the tools or pull the plug from an outlet. Keep cord away from heat, oil, sharp edges or moving parts. Replace damaged cords immediately.** Damaged cords increase the risk of electric shock.
5. **When operating a power tool outside use an outdoor extension cord marked "W-A" or "W".** These cords are rated for outdoor use and reduce the risk of electric shock.
6. **Test the Ground Fault Circuit Interrupter (GFCI) provided with the power cord to insure it is operating correctly before operating machine.** Machine must have a properly functioning ground fault circuit interrupter on the power cord. GFCI reduces the risk of electric shock.
7. **Extension cords are not recommended unless they are plugged into a Ground Fault Circuit Interrupter (GFCI) found in circuit boxes or outlet receptacles.** The GFCI on the machine power cord will not prevent electric shock from the extension cords.
8. **Only use proper three-wire extension cords in good condition which have three-prong grounding plugs and three-pole receptacles which accept the tool's plug.** Use of damaged, inferior, or other extension cords will not ground the tool. Increases the risk of electric shock and bodily injury or death.
9. **Keep all electric connections dry and off the ground.** Reduces the risk of electric shock.
10. **DO NOT touch plugs or tools with wet hands.** Reduces the risk of electric shock.

### Personal Safety

1. **Stay alert, watch what you are doing and use common sense when operating a power tool. Do not use tool while tired or under the influence of drugs, alcohol, or medication.** A moment of inattention while operating power tools may result in serious personal injury.
2. **Dress properly. Do not wear loose clothing or jewelry. Contain long hair. Keep your hair, clothing, and gloves away from moving parts.** Loose clothes, jewelry, or long hair can be caught in moving parts.
3. **Avoid accidental starting. Be sure switch is off before plugging in.** Carrying tools with your finger on the switch or plugging in tools that have the switch on invites accidents.
4. **Remove adjusting keys or switches before turning the tool on.** A wrench or key that is left attached to a rotating part of the tool may result in personal injury.
5. **Do not overreach. Keep proper footing and balance at all times.** Proper footing and balance enables better control of the tool in unexpected situations.
6. **Use safety equipment. Always wear eye protection.** Dust mask, non-skid safety shoes, hard hat, or hearing protection must be used for appropriate conditions.

### Tool Use and Care

1. **Use clamps or other practical way to secure and support the workpiece to a stable platform.** Holding the work by hand or against your body is unstable and may lead to loss of control.
2. **Do not force tool. Use the correct tool for your application.** The correct tool will do the job better and safer at the rate for which it is designed.
3. **Do not use tool if switch does not turn it on or off.** Any tool that cannot be controlled with the switch is dangerous and must be repaired.
4. **Disconnect the plug from the power source before making any adjustments, changing accessories, or storing the tool.** Such preventative safety measures reduce the risk of starting the tool accidentally.
5. **Store idle tools out of reach of children and other untrained persons.** Tools are dangerous in the hands of untrained users.
6. **Maintain tools with care. Keep cutting tools sharp and clean.** Properly maintained tools, with sharp cutting edges are less likely to bind and are easier to control.
7. **Check for misalignment or binding of moving parts, breakage of parts, and any other condition that may affect the tool's operation. If damaged, have the tool serviced before using.** Many accidents are caused by poorly maintained tools.
8. **Only use accessories that are recommended by the manufacturer for your model.** Accessories that may be suitable for one tool may become hazardous when used on another tool.

### Service

1. **Tool service must be performed only by qualified repair personnel.** Service or maintenance performed by unqualified repair personnel could result in a risk of injury.
2. **When servicing a tool, use only identical replacement parts. Follow instructions in the Maintenance section of this manual.** Use of unauthorized parts or failure to follow Maintenance Instructions may create a risk of electric shock or injury.

## SPECIFIC SAFETY RULES



This is the safety alert symbol. It is used to alert you to potential personal injury hazards. Obey all safety messages that follow this symbol to avoid possible injury or death.



Electric shock resulting in death can occur if you plug this machine into an improperly wired outlet. If the ground wire is electrified, you can be electrocuted by just touching the machine, even when the power switch is off. A ground fault circuit interrupter will not protect you in this situation. Use a UL approved tester to determine if the outlet is safe.



Do not overstress cables. Overstressing cables may cause twisting, kinking, or breaking of the cable and may result in serious injury.

1. **Only wear leather gloves.** Never use any other type of glove, such as cloth, rubber, or coated gloves. Never grasp a rotating cable with a rag. These items could become wrapped around the cable and cause serious injury.
2. **Do not overstress cables.** Keep leather-gloved hand on the cable for control when machine is running. Overstressing cables because of an obstruction may cause twisting, kinking, or breaking of the cable and may result in serious injury.
3. **Place the machine at a distance not greater than two feet from the opening.** Greater distances can result in cable twisting or kinking.
4. **Machine is designed for ONE-PERSON operation.** Operator must control foot switch and cable.
5. **Be careful when cleaning drains where cleaning chemicals have been used.** Avoid direct contact with skin and eyes. Drain cleaning chemicals can cause serious burns as well as damage the cable.
6. **Do not operate machine if operator or machine is standing in water.** Will increase risk of electrical shock.
7. **Wear safety glasses and rubber soled, non-slip shoes.** Use of this safety equipment may prevent serious injury.
8. **Before starting each job, check that the cable is not broken or kinked, by checking for wear or breakage.** Always replace worn out (kinked or broken) cables with genuine GENERAL replacement cables.
9. **Only use this tool in the application for which it was designed. Follow the instructions on the proper use of the machine.** Other uses or modifying the drain cleaner for other applications may increase risk of injury.

### Ground Fault Circuit Interrupter (GFCI)

Your machine is equipped with a ground fault circuit interrupter, which protects you against shock if a short circuit should occur. Check that receptacle is properly grounded. Test the GFCI before each use.

1. Plug into 120-volt receptacle.
2. Push test button. Indicator light will go out and power to machine should cut off.

3. If light does not go out when test button is pushed, equipment should not be used until proper repairs can be made.
4. To restore power after test, push reset button. With the reset button depressed, if the machine doesn't start, stops while running, or if the operator experiences a mild shock, **do not use the machine!** Tag the machine out of service and take it to a motor repair center or return it to the factory for repairs.



**THE SECTION OF CORD BETWEEN THE WALL PLUG AND THE GFCI IS NOT IN THE PROTECTED CIRCUIT.**

## FEATURES

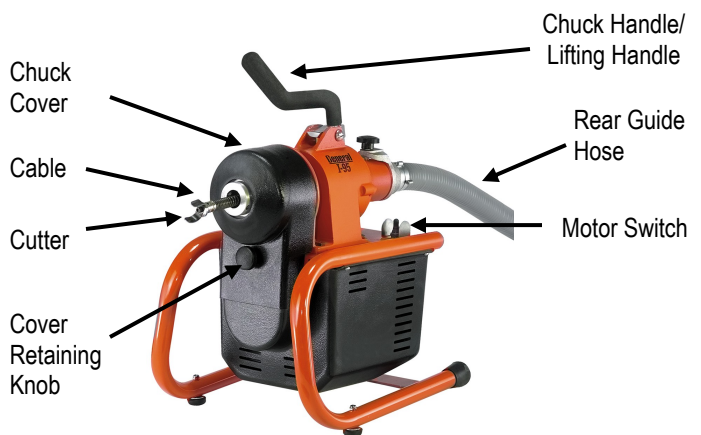

**NOTE:** Do not operate machine if warning labels on the Motor Housing and power cord are missing or illegible.

### Cables and Connectors

Your machine comes with "R" type cable connectors to match Ridgid® -type cables.

To couple "R" cables, put the T-shaped slot in the female connector next to the T-shaped male connector. Slide the two together and the spring pin will snap into place.

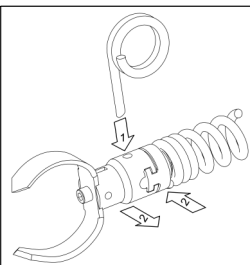
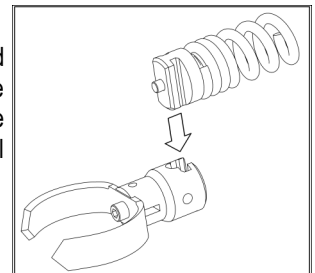

To disconnect, push the coupling key into the hole just below the slot in the female connector, then slide connectors apart



## Sectional Cables Compatible with Ridgid® Cables









7.5R-7	5/8" x 7-1/2 ft. Close-Wound
7.5R-8	5/8" x 7-1/2 ft. Open-Wound
15R-10	7/8" x 15 ft. Open-Wound
15R-10-P	7/8" x 15 ft. Proflex

General makes cables and cutters to fit equipment manufactured by others. We have no affiliation with these companies.

## Cable Application Chart (Table 1)

Cable Size	Pipe Size	Typical Applications	Max.Distance
5/16" (Container)	1-1/2" to 2"	Small lines, tubs, showers	50 ft.
3/8" (Container)	2" to 3"	Sinks, basins, small drains	35 ft.
5/8" Sections	1-1/4" to 3"	Roof stacks, small drains	125 ft.
7/8" Sections	2" to 4"	Medium Lines, Floor Drains	125 ft.

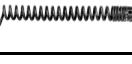
## Cutter Application Chart (Table 2)

Cutter	Cat. #	Typical Applications
Cutters for 5/8" Cables		
Arrow Head 	R-AH	Starting Tool, ideal for cutting and scraping.
1-1/2" U-Cutter 	R-1-1/2UC	Finishing tool, works well in grease stoppages.
Boring Gimlet 	R-BG	To remove or retrieve loose objects.
Small Retrieving Tool 	R-RTR-1	To remove or retrieve loose objects.
Cutters for 7/8" Cables		
Spear Head 	R-SHD-10	Starting Drill—gets water flowing.
2" U-Cutter 	R-2UC-10	For Cutting and Scraping
3" U-Cutter 	R-3UC-10	For Cutting and Scraping
Hook Auger 	R-HA-10	To remove or retrieve loose objects
Large Retrieving Tool 	R-RTR-2	For removing loose objects or broken cables.

Note: There are no fixed rules for what cutter to use. If one tool doesn't take care of a stoppage, simply try another.

## OPERATION

## Set-Up - 5/8" and 7/8" Cables



**MAKE SURE THE MOTOR SWITCH IS IN THE 'OFF' POSITION!**

## Adjustable Chuck Set-Up

The chuck has two sets of notches, one for 5/8" cables and one for 7/8" cables. Use the following procedure to switch between cable sizes:

1. Remove the chuck cover by unscrewing retaining knob.
2. The chuck cone has three small notches for 5/8" cables and three large ones for 7/8" cables. They are marked accordingly.
3. Squeeze the three jaws together while rotating the chuck cone to the desired setting.
4. Replace the chuck cover and screw in the retaining knob.

7/8" JAW SETTING

5/8" JAW SETTING

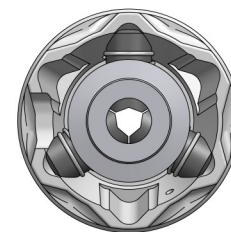
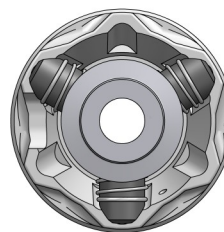

## Machine Set-Up

1. Place machine at a distance of not greater than two feet (.6m) of drain opening. If you can't place the machine this close to the drain opening, run the cable through a pipe or a metal guide tube to prevent cable whipping.
2. Attach Rear Guide Hose (66-RGH) by aligning knob on guide hose with indent on rear of machine and tighten.
3. Slide cable, female connector first, into front of machine. Never use more than one cable at a time.
4. Insert cutting tool into male connector at other end of cable. Start with the small cutters to get the line open. After the line is opened, follow with larger blades, which scrape the inside walls of the pipe, assuring a real cleaning job.



## OPERATION - 5/8" and 7/8" CABLES



**MAKE SURE THE MOTOR SWITCH IS IN THE 'OFF' POSITION!**

1. Push the cable into the drain opening as far as it will go. Then pull an additional foot of cable from the machine so that an arc is formed.
2. Turn the motor switch to the **forward** position. The motor will start running.
3. Put one gloved hand on the cable then push the chuck handle down with the other. The cable will spin into the line. Guide the cable into the line with a firm even pressure. **Do not force the cable.** You won't clear the line any faster and you could damage the cable. Too much cable between the machine and drain will cause the cable to whip and kink.

**DO NOT USE TOO MUCH FORCE –  
LET THE CUTTER DO THE WORK.**

- When the slack in the cable is gone, release the handle and pull another foot of cable from the machine. Pull handle down again and continue to feed the cable.



**DO NOT ALLOW TOO MUCH SLACK IN THE CABLE BETWEEN MACHINE AND DRAIN OPENING SINCE THIS CAN CAUSE CABLE WHIPPING.**

- When you reach the end of the sectional cable, pull it out of the machine and slide another cable into the machine, female end first. couple the ends together and continue feeding.
- When you reach the stoppage, move the cable back and forth as the cable is rotating until the stoppage is cleared.
- When the obstruction is cleared, retract the cable. Keep the motor switch in the **forward** position. Running in reverse can damage the cable. Use reverse only if the cable gets caught in the line. Using the machine in reverse for more than a few seconds can damage the cable.



**DO NOT USE REVERSE TO PULL THE CABLE OUT OF THE DRAIN. RUNNING MACHINE IN REVERSE FOR EXTENDED PERIODS CAN DAMAGE CABLE.**

- Push the cable against the lip of the pipe while holding the chuck handle down. The cable will corkscrew out of the line. When about a foot of cable emerges from the drain, release the clutch handle and slide the cable into the machine. Repeat until a complete section is removed from the line. Then disconnect the cable and remove it from the machine. Continue until all sections are removed.

**Hint:** It's often helpful to have a small stream of water running in the line to wash the cuttings away while the machine is in operation and after.

## OPERATION

### Set-Up - 5/16" and 3/8" Cables



**MAKE SURE THE MOTOR SWITCH IS IN THE 'OFF' POSITION!**

#### Container Set-Up

To attach container to machine:

- Pull cable out of container about a foot. Then slide container onto rear of machine allowing cable to slide through the machine body.
- Depress the chuck handle to relieve spring pressure and allow the container casting to fully seat.
- Align knob on container with indent at rear of machine and tighten.

#### Machine Set-Up

- Attach a cutter to the 3/8" cable by sliding the cutter into the slot in the female connector at the end of cable, then tighten in place **firmly** with connecting screw **and** lock washer.
- Place machine at a distance of not greater than two feet (.6m) of drain opening. If you can't place the machine this close to the drain opening, run the cable through a pipe or a metal guide tube to prevent cable whipping.



## OPERATION - 5/16" and 3/8" CABLES



**MAKE SURE THE MOTOR SWITCH IS IN THE 'OFF' POSITION!**

- Push the cable into the drain opening as far as it will go. Then pull an additional foot of cable from the machine so that an arc is formed.
- Turn the motor switch to the **forward** position. The motor will start running.
- Put one leather-gloved hand on the cable then push the chuck handle down with the other. The cable will spin into the line.

**Note:** To insure that the feed grips the cable properly without excessive wear to clutch jaws, pull the chuck handle down sharply when engaging the feed. Pull handle back fully to disengage the feed. Pulling the handle back will activate a brake that stops the container used for 5/16" and 3/8" cables from spinning.

- Guide the cable into the line with a firm even pressure. **Do not force the cable.** You won't clear the line any faster and you could damage the cable. Too much cable between the machine and drain will cause the cable to whip and kink.

**DO NOT USE TOO MUCH FORCE –  
LET THE CUTTER DO THE WORK.**

- When the slack in the cable is gone, release the handle and pull another foot of cable from the machine. Pull handle down again and continue to feed the cable.



**DO NOT ALLOW TOO MUCH SLACK IN THE CABLE BETWEEN MACHINE AND DRAIN OPENING SINCE THIS CAN CAUSE CABLE WHIPPING.**

- When you reach the stoppage, move the cable back and forth as the cable is rotating until the stoppage is cleared.
- When the obstruction is cleared, retract the cable. Keep the motor in the **forward** position. Running in reverse can damage the cable. Use reverse only if the cable gets caught in the line. Using the machine in reverse for more than a few seconds can damage the cable.



**DO NOT USE REVERSE TO PULL THE CABLE OUT OF THE DRAIN. RUNNING MACHINE IN REVERSE FOR EXTENDED PERIODS CAN DAMAGE CABLE.**

**Hint:** It's often helpful to have a small stream of water running in the line to wash the cuttings away while the machine is in operation and after.

## MAINTENANCE



**DISCONNECT MACHINE FROM POWER SOURCE  
BEFORE PERFORMING MAINTENANCE!**

To keep your machine operating smoothly, it is essential that all bearings be lubricated. Oiling moving parts is particularly important where machine comes in contact with sand, grit, and other abrasive material.

### CABLE MAINTENANCE

To get maximum service from your cables, be sure that they are clean and well oiled. Some users periodically pour oil directly into the container. This not only provides running lubrication, but greatly extends the life of the cables as well. Our SNAKE OIL is ideally suited for this purpose, since it not only lubricates the cables, it deodorizes them as well.



### TO RESET THERMAL OVERLOAD SWITCH

The motor is equipped with thermal overload protection to guard against damage from overheating. If the motor shuts down:

1. **Unplug the machine** and let the motor cool down.
2. Then, insert a pencil into the hole at the back of the motor housing to press the red reset button.

### TO CLEAN OR REPLACE JAWS

1. Remove chuck cover by unscrewing retaining knob.
2. Remove the slot head screw from the chuck cone.
3. Squeeze the three jaws together and rotate the chuck cone until a jaw becomes accessible in the open space.
4. Follow the same procedure to remove and clean or replace each chuck jaw.
5. When complete, be sure to replace the slot head screw to prevent accidental removal of a jaw.
6. Replace the chuck cover and screw in the retaining knob.

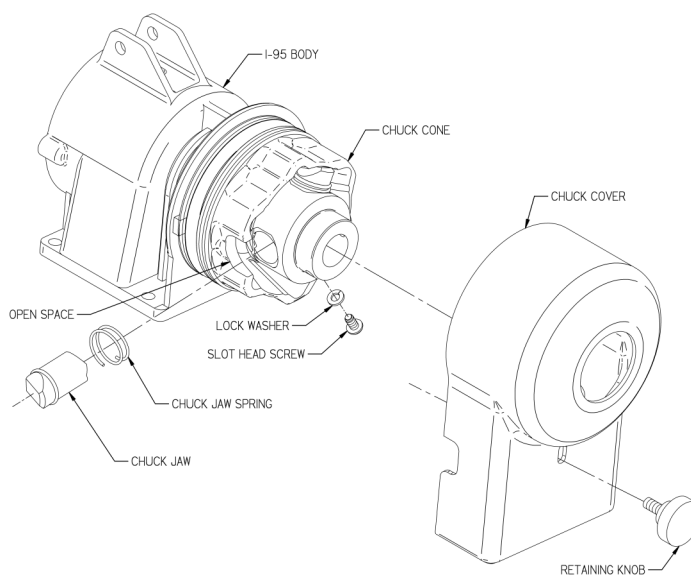

### Trouble Shooting Guide (Table 3)

Problem	Probable Cause	Solution
Cable kinks, tangles or breaks.	Operator forcing the cable.	Do not force the cable. Let the cutter do the work.
	Too much slack between machine and drain.	Do not allow slack between machine and drain.
	Cable used in wrong size drain line.	A cable that is too large or too small in diameter for a line is more likely to kink. (Consult Table 1—Cable Applications.)
	Cable exposed to acid	Clean and oil cables regularly.
	Motor running in reverse.	Motor must rotate in forward direction when feeding and retracting cable.
Chuck slips.	Dirt build-up or lack of lubrication.	Disassemble chuck, clean and lubricate assembly. Lubricate regularly as per instructions. Badly worn jaws must be replaced.
	Kinked Cables.	Kinked cables will not fit through chuck. Repair or replace damaged sections.
Motor turns in one direction but not other.	Reverse switch failure.	Replace reverse switch.
Ground Fault Circuit Interrupter trips and will not reset.	Damaged power cord or extension cord.	Replace cords.
	Short circuit in motor.	Take motor to authorized repair center.
	Faulty ground fault circuit interrupter.	Replace Ground Fault Circuit Interrupter.
Motor will not run.	Thermal overload protection engaged.	Unplug machine and let motor cool down. Then, press reset button at back of motor.

## I-95 PARTS LIST

CAT. NO.	DESCRIPTION	CAT. NO.	DESCRIPTION
95-100	Frame Complete	95-25-0	Small Container (for 5/16" Cables)
95-101	Frame Only	95-401	Small Container Shell & Spindle
95-102	Rubber Feet, Bolts, Nuts & Lock Washers (2)	95-403	Ball Bearing
95-103	Rubber Leg Tips (2)	95-404	Mounting Collar w/Knob
95-104	End Plugs (2)	95-404-A	Knob
95-106	Cutter Holder	95-404-B	Set Screws (3)
95-107	Screws & Washers (2)	95-404-C	Grease Fitting
95-110	Motor Guard	95-405	Flange Bearing Set (2)
95-111	Screws for Motor Guard (4)	95-407	Fiber Washers (3)
95-115	Belt Guard	95-408	Brake Disc
95-116	Belt Guard Retaining Knob	95-409	Spacer
95-117	Washer (glued to belt guard)	95-410	Slotted Tube
95-118	Belt Tension Adjustment Screw	95-411	Snap Ring
95-200	Chuck Assembly	95-35-0	Large Container (for 3/8" Cables)
95-201	Chuck Housing	95-451	Large Conatiner Shell
95-201-A	Chuck Housing Bolts (4)	95-451-A	Container Front
95-201-B	Grease Fitting	95-451-B	Container Back
95-201-C	Cover w/Screw	95-451-C	Screws & Clips (3)
95-202	Rear Housing	95-452	Spindle for Large Container
95-202-A	Rear Housing Bolts (2)	95-456	Washer (2)
95-202-B	Grease Fitting	95-457	Thrust Bearing Race
95-203	Brake Stop, Screw & Washer	95-465	Nut
95-204	Brake Spring	95-600	1/3 hp Motor w/Reverse Switch & GFCI
95-205	Brake Sleeve	95-601	Motor Pulley w/Set Screw
95-210	Linkage (4)	95-602	Mounting Bolts, Nuts & Washers
95-211	Sleeves (6)	95-603	Notched V-Belt
95-212	Button Head Cap Screw (6)	95-604	GFCI w/10 ft. Power Cord
95-213	Linkage Spacers (4)	95-605	Reverse Switch Assembly
95-215	Yoke	95-605-A	Terminal Boot
95-216	Self Locking Nuts (2)	95-605-B	Wire Loom
95-220	Chuck Slide	95-605-C	Cord Clamp & Screw
95-224	Threaded Collar w/Screws	95-605-G	Reverse Switch Only
95-225	Chuck Shaft	95-605-H	Toggle Boot
95-226	Ball Bearing	95-605-J	Toggle Guard
95-230	Chuck Body	95-610	Baffle
95-230-A	Set Screws (2)	95-611	Baffle Nuts (2)
95-230-C	Jaw Locating Ring	95-611-1	Baffle Nuts (2)
95-233	Jaw Springs (3)	95-612	Baffle Spacer Washers (4)
95-234	Chuck Jaws w/Rings (3)	95-612-1	Baffle Spacer Washers (2)
95-235	Thrust Bearing & Races	95-613	Baffle Bolts (2)
95-240	Chuck Cone	95-RGH	Rear Guide Hose
95-240-A	Limit Screw & Lock Washer		
95-242	Return Spring		
95-245	Handle Assembly		
95-245-A	Handle Only		
95-245-B	Rubber Grip		
95-245-C	Bolt & Nut		
95-245-D	Handle Adjustment Screw		



